







ENVIROFLEX® - L150 (6")

SALES & ENGINEERING DATA SHEET



Highlights

-  Extended hose life and significant power savings when compared to other Peristaltic pumps
-  Essentially one wearing part means low maintenance and low spares inventory
-  Ideal for corrosive environments with casing options in 304 or 316 stainless steel with a wide variety of hose materials
-  Accurate, controllable and reversible flow rate means easy integration with your process requirements
-  Excellent dry run, solids & sludge handling capabilities with no check valves or expensive sealing arrangements
-  Self Priming suction lift up to 9 metres maximum
-  Fixed and variable speed control options available with vertical angled gearboxes and motors if required

Technical Specifications

- Maximum Working Pressure: 10 BarG (145 PsiG)
- Fluid Displacement Per Rev: 70 Litres (18.492 US Gallon)
- Maximum Continuous Working Speed: 25 RPM
- Maximum Intermittent Working Speed: 35 RPM
- Maximum Operating Temperature: 100°C (212°F)
- Maximum Soft Solids Capability: 120 mm (4-3/4")
- Maximum Hard Solids Capability: 22.5 mm (7/8")
- Maximum Suction Lift on water: 9 Metres (27 feet)
- Typical Weight (Varies with drive): 1800 Kg (3960 lbs)

Hose Materials

- Natural Rubber (Industrial and Food Grade)
- Nitrile Rubber (Industrial and Food Grade)
- EPDM Rubber (Industrial and Food Grade)
- CSPE Rubber
- Viton Rubber

Hose Connections

- Victaulic (Standard)
- Flange PN10/ANSI
- Sanitary Connections (Tri-Clamp, DIN)
- Any Connection Can Be Supplied on Request

Hose Connection Materials

- 304 Stainless Steel (standard)
- 316 Stainless Steel
- Hastelloy-C

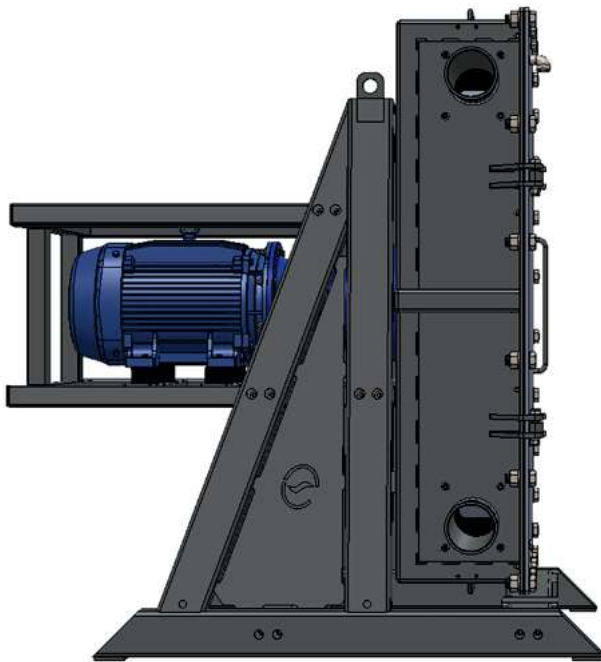

ENVIROFLEX® - L150 (6")

SALES & ENGINEERING DATA SHEET

Enviroflex® L150 Performance Curve

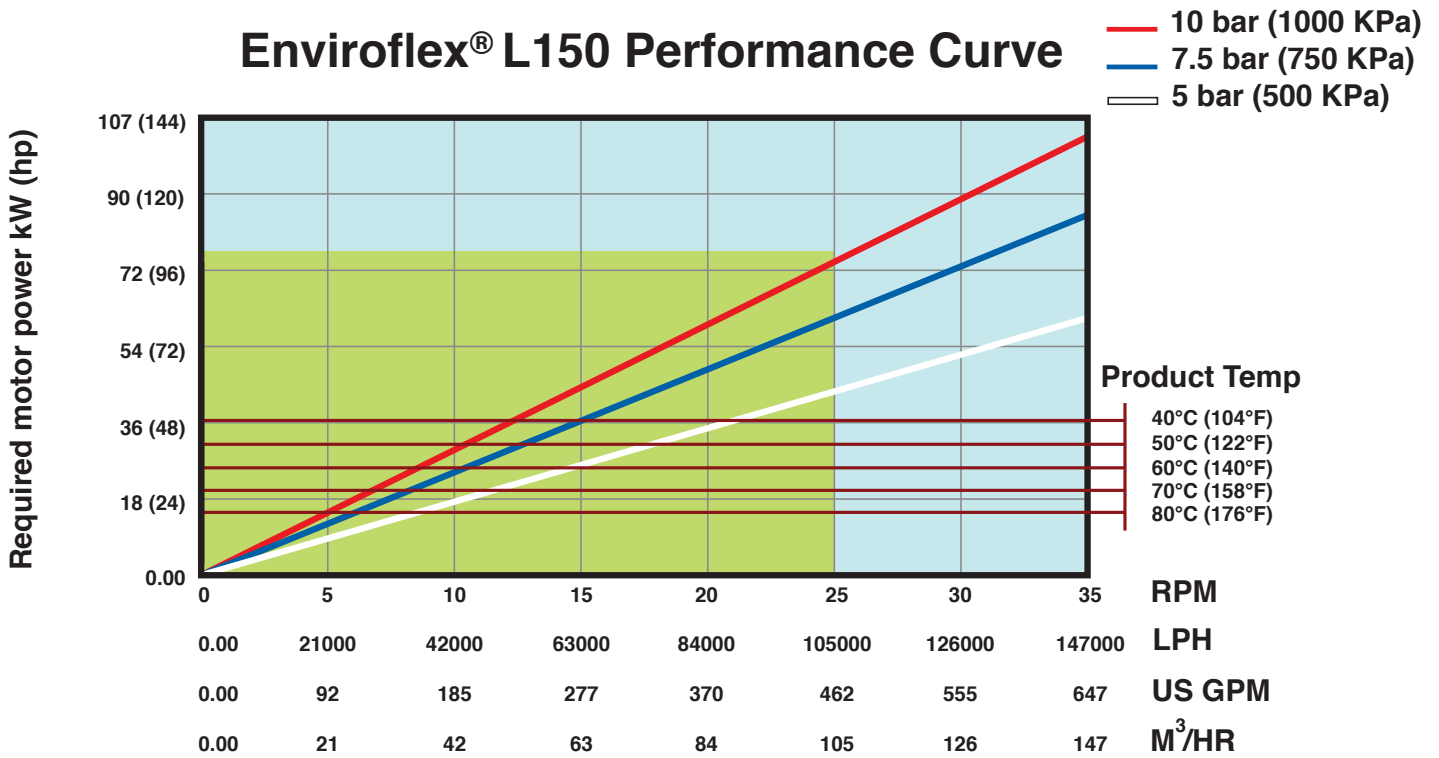

Continuous duty
Intermittent duty
(maximum 1 hour operation followed by 20 minute rest)

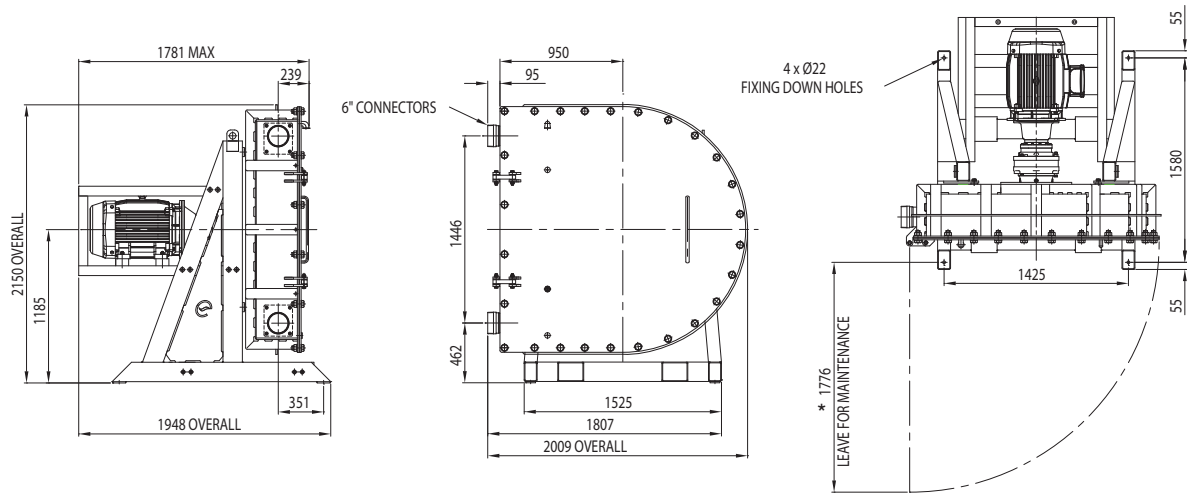

Dims: Approx. mm

* Note: When using hinged front cover
(non hinge option available please enquire)

